



LUNE™

Lune™ is the very essence of a warm and cosy setting, with a dash of exclusivity and urbanity added. Lune combines the renowned Republic of Fritz Hansen™ quality with a functional modular system. The result is a playful design where designer Jaime Hayon's characteristic curves are elevated to create an extremely comfortable sofa that looks beautiful from every angle and works as well for a party of two as for ten.



REPUBLIC OF **Fritz Hansen**®

INTRODUCING A NEW PARADIGM IN MODULAR SOFAS

Meet Lune™, Jaime Hayon's take on a modern modular sofa. The word "lune" exists only in Danish and the meaning of it is both a reference to a temperature and to a feeling of comfort. With Lune, Jaime Hayon has taken the flexibility of a modular sofa and added an aesthetic layer to it. The result is a sofa built by several modules with the visual appearance of one singular sofa.

After seven years of collaboration with Fritz Hansen, Jaime Hayon has created a design built on simplicity and urbanity with family ties to his existing pieces, Ro™ and Fri™. Combined with the quality and craftsmanship of Republic of Fritz Hansen™, Lune is a sofa suited for ultimate relaxation with an aesthetic appearance.

Lune is a modular sofa created with unlimited ways of shaping it - from a straight two-seater to bigger L-shapes and chaise lounge options.

DESIGN

Jaime Hayon, 2017.



JAIME HAYON 1974-

Spanish artist/designer Jaime Hayon was born in Madrid in 1974. As a teenager, he submerged himself in skateboard culture and graffiti art, which formed the detailed, bold yet whimsical imagery so prevalent in his work today.

In 1997, after studying industrial design in Madrid and Paris, he joined Fabrica, the Benetton-funded design and communication academy, working closely with the legendary image-maker and agitator Oliverio Toscani.

After a short time he was promoted from student to head of their Design Department. Eight years later, Jaime broke out on his own, first with his collections of designer toys, ceramics and furniture, then followed by interior design and installations.

UPHOLSTERY

For Lune™ we have chosen the upholstery quite meticulously. The choice of fabric of the Designer Selections is cotton only, with the purpose of creating a comfortable seat with an exceptionally soft touch. The fabric, Linara by Romo, is a cotton-linen blend fabric; it is piece dyed meaning that colour differences can appear within batches and make each upholstery - and each sofa - a unique item. The blend of cotton and linen too causes certain visible slubs and neps to the fabric. Note that these are natural characteristics of the cotton and are not to be treated as flaws. Martindale is 36.000.

The Designer Selections are:

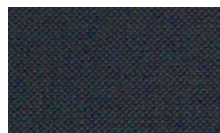

BLUEBERRY
FABRIC: LINARA 2494/198

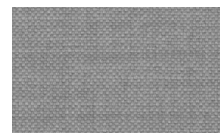

EUCALYPTUS
FABRIC: LINARA 2494/324



GINGERSNAP
FABRIC: LINARA 2494/118

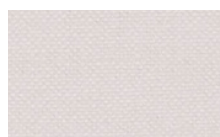

GREY MIST
FABRIC: LINARA 2494/340



INDIGO
FABRIC: LINARA 2494/30



LEAD
FABRIC: LINARA 2494/237

Lune is also available in the following selection of fabrics and leathers:

Fritz Hansen Colours: The Fritz Hansen Colours are created exclusively by Republic of Fritz Hansen's own design team and consist of serene pale pink, warm and earthy terracotta orange and finally deep ocean blue.

Fabrics: Canvas, Capture, Diablo, Fame, Fiord, Divina, Divina Melange, Divina MD, Hallingdal, Remix, Steelcut, Steelcut Trio, Sunniva and Tonus.

Leathers: Classic, Soft and Sense.

BASE



OAK



BLACK COLOURED OAK

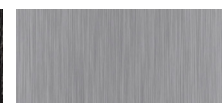

BRUSHED ALUMINIUM

The oak wood on the base is FSC Certified.





WARRANTY

A five-year warranty against manufacturing defects in standard products (materials and workmanship). Wear, tear and damage to the product are not covered under this warranty. Claims from end users under the guarantee must be submitted to the vendor from whom the product was purchased. All measurements are indicative.

STANDARD WARRANTY:

5 years

MY REPUBLIC EXTENDED WARRANTY:

5 years: Fabric, Legs, Cushions, Leather: Soft.

10 years: Shell, Leather: Classic, Sense.

To obtain an extended warranty offered through My Republic the products should be registered online. Go to www.fritzhanzen.com/myrepublic to register.

CUSHIONS AND FOAM

The main characteristic of Lune™ is its comfort. This feature has been enhanced not only in the choice of the cotton fabric, but also in the way the sofa is constructed.

In order to provide the best seating feeling, the cushions are made of four layers of materials: A layer of support webbing at the bottom, the cushion foam in the middle and a layer of feathers made of duck and goose on top of it, all covered by the upholstery fabric.

When seated, one feels the comfort and softness of the material instantly, as the cushions shape with the body. This characteristic of comfort will cause the cushions to remain shaped when getting up from the sofa - with a quick tap or two, the sofa will return to its original appearance.

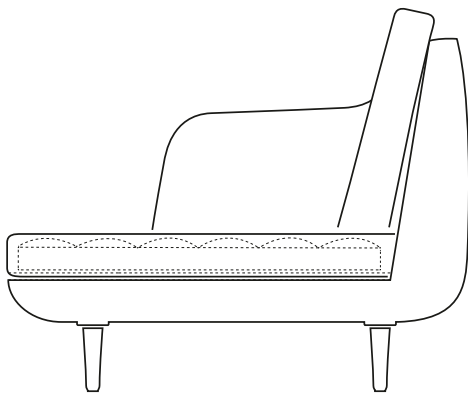

ASSEMBLY

The modular nature of the Lune™ sofa has been constructed to make assembly as easy and smooth as possible. It can be performed in any environment with only a few tools. The modules are provided with a keyhole and a corresponding pre-mounted and adjustable screw which links the top of the modules together with an assembly bracket to secure the modules underneath. Furthermore, thanks to the predrilled holes and embedded screws, the legs can be mounted and dismantled quickly.

Assembly guidelines will be included in the packaging.



VARIATIONS & DIMENSIONS

JH200

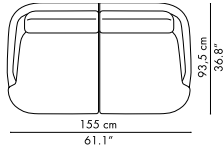

JH300

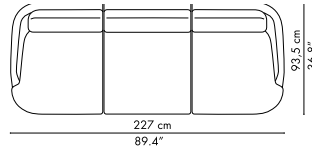

JH400

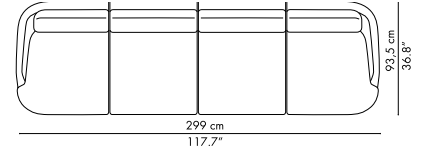

JH301

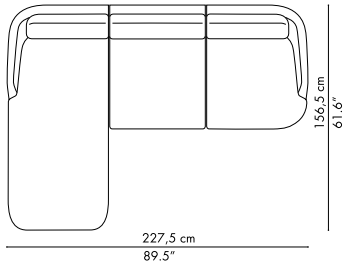

JH302

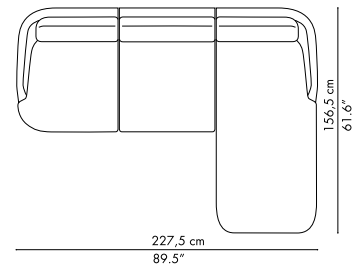

JH500

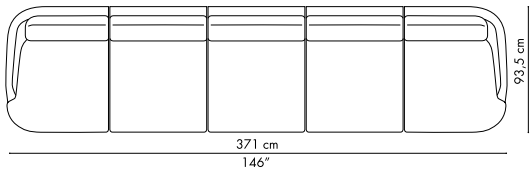

JH600

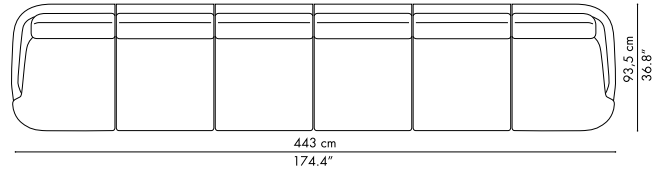

JH510

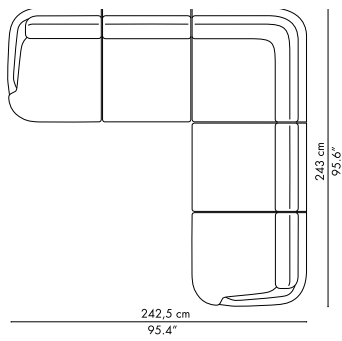

JH610

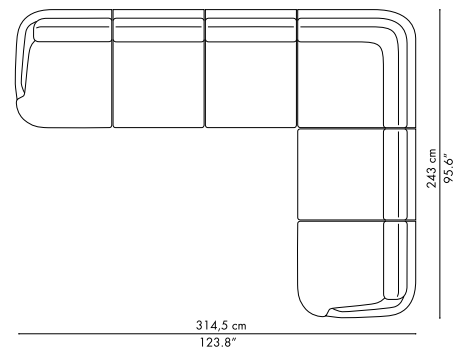

SOFA MODULES

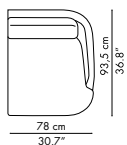
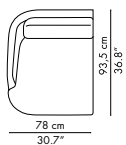
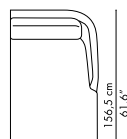
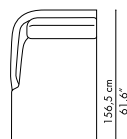
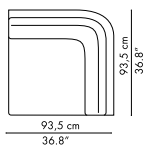
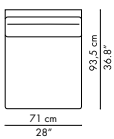

ENVIRONMENTAL PRODUCT INFORMATION

Modular sofa system for domestic and non-domestic seating.

MATERIALS

Shell: Plywood / EPP (approx. 80/5%)

Upholstery: HR60 10mm / Fabric (approx. 5%)

Base: Wood or aluminium (approx. 8%)

Fittings: Powder coated steel (approx. 2%)

Materials in %

The below figures illustrate the weight allocation between the different materials used. Items with a weight <1% of the total product weight are not included in the figures below. The upholstery percentage may vary depending on the upholstery type. Weight distribution (%) is dependent on the configuration chosen.

Model JH001 - central module

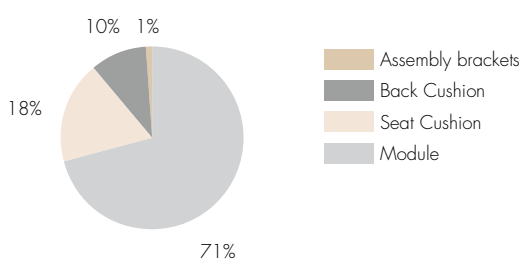

Model JH002 - arm module

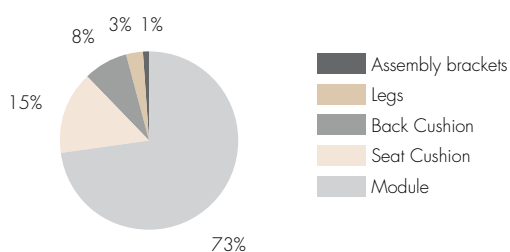

Model JH003 - corner module

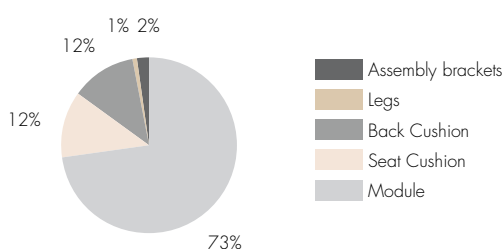

Model JH004 - chaise longue

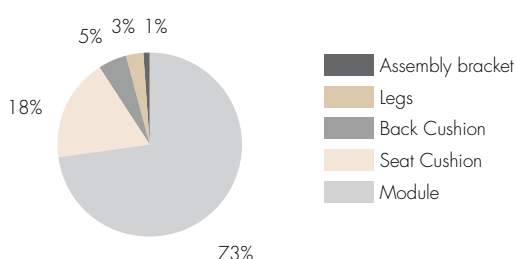

PACKAGING MATERIAL

The sofa modules is covered with a PE plastic bag and padded with PE foam and shipped and protected in cardboard. All packaging material can be recycled.

REPAIR, DISPOSAL AND REUSE

In the case of disposal, the aluminium legs and other fittings can be removed for separate recycling. Check local regulations for recycling in your area and whether there is potential for reuse.

MANUFACTURING PROCESS

Suppliers

Suppliers' environmental stance is examined as part of Fritz Hansen's Quality and Environmental Management Systems before Fritz Hansen enters into collaboration with a supplier.

Plastic

EPP (Expanded polypropylene) parts are embedded in arm- and corner modules.

Metals

Production scrap is collected for recycling.

MANAGEMENT SYSTEMS

Environmental Systems

We are aware of our environmental responsibilities. Therefore, in the autumn of 2004 Fritz Hansen obtained the ISO 14001 certification in the environmental management system. The certification is a guarantee to our customers and the authorities that we comply with the requirements of the ISO 14001:2015 standard.

Quality System

Fritz Hansen is also certified according to the quality system ISO 9001:2015.

Employee Health and Safety

Fritz Hansen aims at meeting or exceeding OSHA standards.

LONG LIFETIME

A long lifetime of a piece of furniture is an important environmental factor. Fritz Hansen aims to obtain a long lifetime through timeless design and strict requirements for strength, durability and stability.

The sofa complies with the requirements to the following standards:

- EN 16139 Strength, durability, stability and safety, Non domestic seating - Test Level 2.
- EN 1728 Strength and durability
- EN 1022 Stability

MORE INFORMATION

Please visit www.fritzhanzen.com for additional environmental information and to download our Perspective on Sustainability & Corporate Environmental Policy.